

PSC-ND-I-CM-DC-BLE-SR | Wireless PIR Ceiling Mount Sensor

Overview

- PIR sensor
- Bluetooth® SIG mesh
- LED Motion indicator
- Mounting height up to 12ft (3.6m).
- 360° coverage pattern
- Technology Partner SILVAIR



Suitable for indoor use only

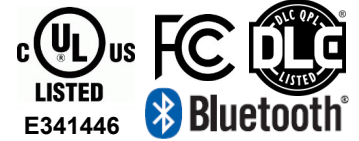

Applications

The PSC-ND-I-CM-DC-BLE-SR uses digital PIR Motion Detector Architecture and passive infrared (PIR) technology for improved detection coverage for ceiling mount applications.

The sensor is suitable for a variety of indoor applications. It supports ceiling mounts up to 12ft high. Both sensor and power pack are rated for use in temperatures ranging from -30° to 70°C and relative humidity from 90 to 95% at 30°C.

Sensor Operation

TruBlu™ Mesh Controls: Qualified for Bluetooth Mesh 1.0.1 (SIG), the sensor can pair with an iOS application to allow initial setup and subsequent sensor adjustments. The mobile application enables adjustment of sensor parameters such as time delay, and more.

Additionally, features such as parameter profiles, and real-time feedback from the sensor can speed up configuration and provide custom user control. See TruBlu™ Commissioning User Manual for more info.

Accessories

Power Pack: The PSC-ND-I-CM-DC-BLE-SR operates on 12-24VDC input and requires a separate power pack such as the PacWave™ PSC-AC-PP-200/400/700C/800/900.

Alternatively, the sensor can also operate with a driver that has an auxiliary output (12V).

Summary

Sensor Type:
PIR occupancy sensor

Input Voltage | Current Consumption:
12-24 VDC | 50 mA

Mounting Height:
Ceiling mount up to 12ft (3.6m)

Max Range¹:
37ft (11.3m) radius

Max Bluetooth Range²:
49 ~ 65ft (15 ~ 20m)

Operating Temperature:
-30° C to 70° C

Storage Temperature:
-40° C to 80° C

Relative Humidity:
90-95% non-condensing

Color: White

Warranty: 5 years

Note:

1. The application/absolute range of the sensor is subject to variation because of different types of clothing, backgrounds, and ambient temperature. Therefore, ensure *that* the lens is properly oriented along routes with expected traffic and conduct testing along those routes.

2. Bluetooth Range is highly dependent on the integration of fixtures, surrounding environment and conditions. It is recommended to conduct testing for range accuracy.

How to Order

For Line to Low Voltage Power Supply/Controller, please check PacWave™ PSC-AC-PP-200/300/400/700C/800/900.

Model No.	Description	Input Voltage
PSC-ND-I-CM-DC-BLE-SR	Passive Infrared (PIR) Ceiling Mount Occupancy Sensor, with Bluetooth Mesh in TruBlu™	12-24VDC

Physical Dimensions

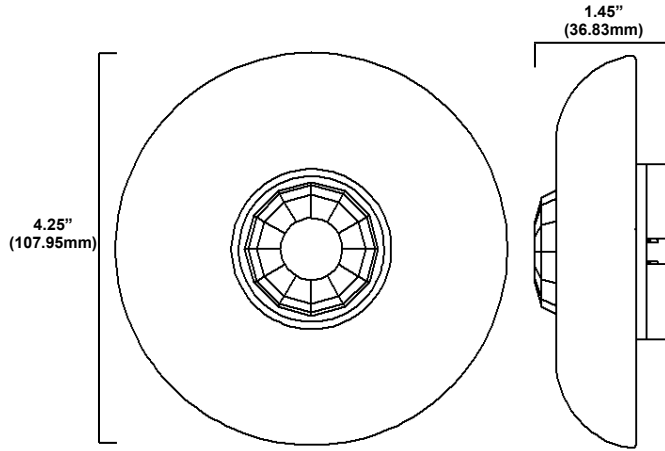

Drawings are Not to Scale

Detection Area

LBL: Low Bay Lens-Top View at 12 ft (3.4m)

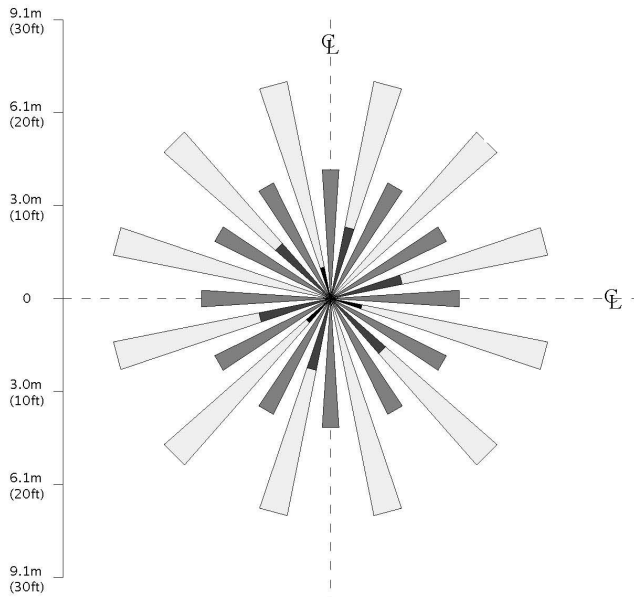

LBL - Side View

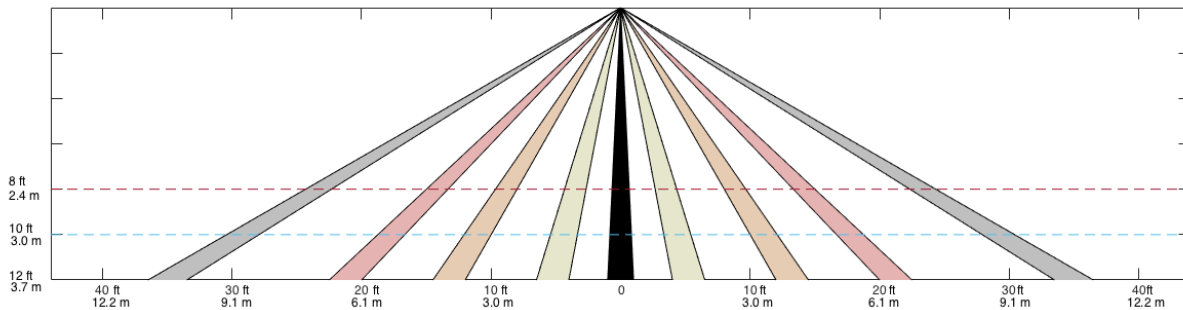

Wiring Diagram

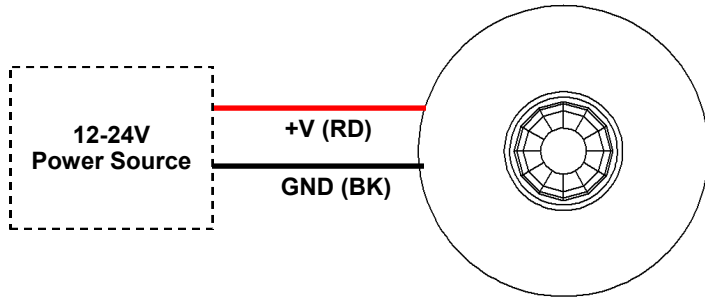

Installation

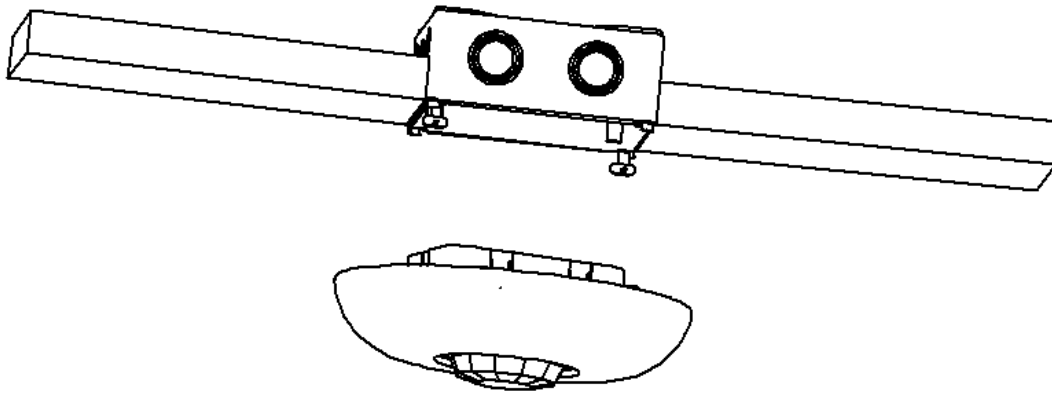

Leads: Minimum 22AWG

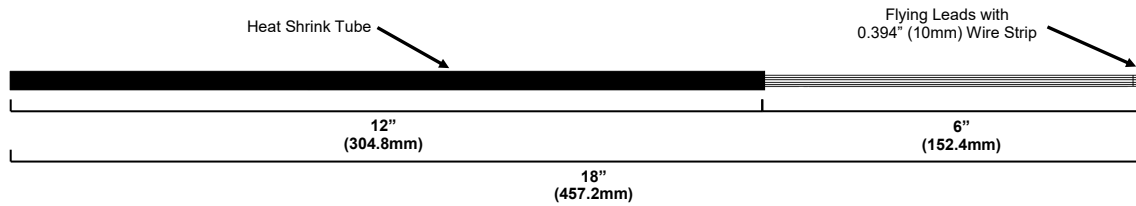

Tolerance ±1" (25.4mm)