

Main Features:

- Input Voltage: 90~305Vac or 127~420Vdc
- Output Wattage: Constant Voltage (C.V.) at **200W**
- High Efficiency: Up to **90%**
- Dimming Function: **0-10V**
- Auxiliaire Voltage : **12Vdc** Aux and **300mA** max
- Lightning Protection: Built-in Surge Protector at 10KV/4KA
- Reliability Protection: OVP, SCP, OTP
- Safety Regulation: Complies with UL8750 & EN61347
- **Type TL and HL** Program Certified from UL
- **Class P** UL standard for retrofit kit
- Waterproof Rating: IP67
- Five Year Warranty under Normal Usage Conditions

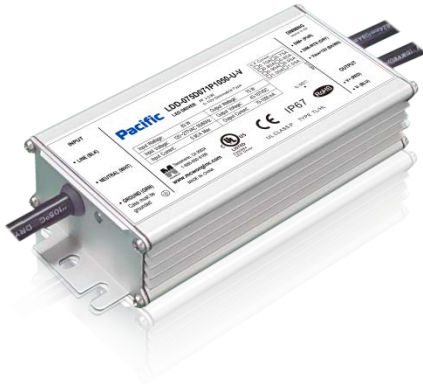

SPECIFICATION

Model No. ⁽ⁱ⁾	Output Voltage	Output Current Range	OVP	OTP	Case Temperature
	C.V. Rated (Vdc)	I _{min} - I _{max} (mA) ⁽ⁱ⁾	(Vdc max.)	(°C) ⁽ⁱⁱ⁾	(Tc)
LDP-200D024-8300-U-V	24	0 – 8300	120% V _o max, typ.	Tc ≥ 105 ± 10°C	90C
LDP-200D048-4200-U-V	48	0 – 4200	120% V _o max, typ.	Tc ≥ 105 ± 10°C	90C
Note	(i) Pre-set Constant Current Value with dimming				
	(ii) Lower the output current when Tc ≥ 105 ± 10°C; Auto Recovery When Tc ≤ 70 ± 10°C				

Input Spec.	Condition Description	Min.	Normal	Max.	Units
Input Voltage Range	Universal Input	90	100-277	305	VAC
Input Frequency Range		47	50/60	63	Hz
Input Current	110 VAC/220 VAC input, full load output			2.20/1.10	A
Power Factor	At 100 VAC/220 VAC input		>0.9		
THD (total harmonic distortion)	@60% - 100% load		<15		%
Inrush Current	At 230 VAC / 277 VAC input, 25°C cold start, 1.2/1.3ms duration			65 / 70	A
Leakage Current	1mA max @277Vac 60Hz, UL8750, 0.75mAmax @220Vac 50Hz, IEC61347-1		0.75	1	mA
Surge Protection	Line to line 6kV, line to ground 10kV, IEC 61000-4-5				

Output Spec.	Condition Description	Min.	Normal	Max.	Units
Current Accuracy			±5		%
Ripple Current	At 100%-60% Load. The result differs according to different LED load characteristic.			5	% Ip-p (Io)
Overshoot/Undershoot	% of lout max & LED load			10	%
Turn-On Delay	Measured at 110 VAC/220 VAC input and Full Load			1.2	S
Auxiliary Power (Vaux)	With 300mA max	-5%	12	+5%	Vdc

General Spec.	Condition Description	Min.	Normal	Max.	Units
Efficiency	Measured at full load and 220Vac in the thermal balanced condition.		90	92	%
MTBF	measured at Tc= 75°C (MIL-HDBK-217F)		≥320,000		Hours
Lifetime	measured at Tc= 75°C		≥100,000		Hours
Operating/Storage Temperature	10%RH/5%RH~100%RH (See De-rating Curve for more details)	-40/-40		70/85	°C
Dimension (OL/L x W x H)	OL is the overall length with mounting plates	242/215 x 68 x 38.5			mm
		9.53/8.46 x 2.68 x 1.52			inch
Weight	Net weight without package	2.64/1.20			lb/kg

Safety & EMC Compliance	Category	Condition Description
Safety Regulations	UL8750	Light Emitting Diode(LED) Equipment for Use in Lighting Products
	UL1012	Power Unit Other Than Class 2
	IEC 61347-1	Lamp Controlgear Part 1: General and Safety Requirements
	IEC 61347-2-13	Lamp Controlgear Part 2-13: Particular Requirement for d.c. or a.c. Supplied Electronic Controlgear foe LED Modules
	CE	Europe: EN 61347-1, EN61347-2-13
EMI Standards	IEC 55015	Conducted emission test & Radiated emission test
	IEC 61000-3-2	Harmonic current emissions; Class C (≥75% load)
	IEC 61000-3-3	Voltage fluctuations & flicker
	FCC Part 15	Class B
EMS Standards	IEC 61000-4-2	Electrostatic discharge (ESD)
	IEC 61000-4-3	Radio frequency electromagnetic field susceptibility test (RS)
	IEC 61000-4-4	Electrical fast transient (EFT)
	IEC 61000-4-5	Surge immunity test
	IEC 61000-4-6	Conducted radio frequency disturbances test (CS)
	IEC 61000-4-8	Power frequency magnetic field test
	IEC 61000-4-11	Voltage dips
	IEC 61547	Electromagnetic immunity requirements applies to lighting equipment

■ Dimming Curve

Parameter	Min.	Typ.	Max.
Vdim Sourcing Current	200uA	300uA	450uA
Vdim Allowed Input Voltage	-20 V		20 V
0-10V Dimming Range	10% (Vdim=1V)	Linear	100% (Vdim=9~10V)
PWM Dimming Range	10% (Duty=10%)	Linear	100% (Duty=90-100%)
Dim off threshold		0.5V or 5%	0.6V or 6%
Dim on threshold	0.6V or 6%	0.7V or 7%	
PWM High	3V		10V
PWM Low	0V		0.6V
PWM Frequency	300Hz		2kHz
External PWM Controller Current Sinking Capability	300uA		

Dimming Wire

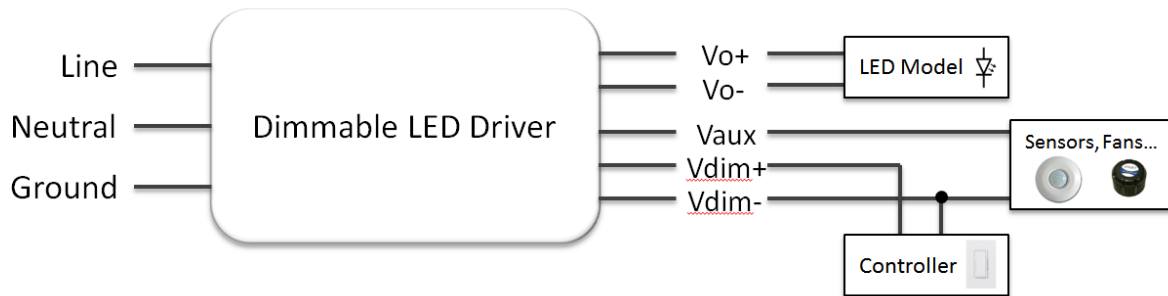

With dim-off (dto)

0-10V Dimming Curve

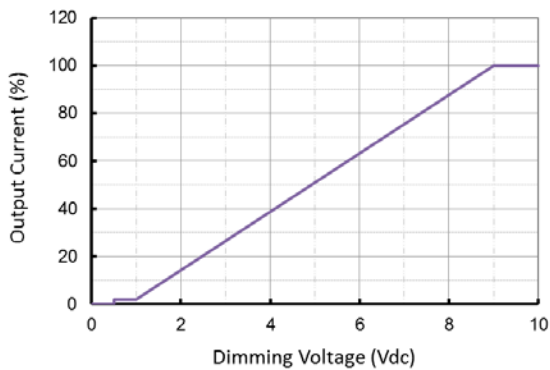

PWM Dimming Curve

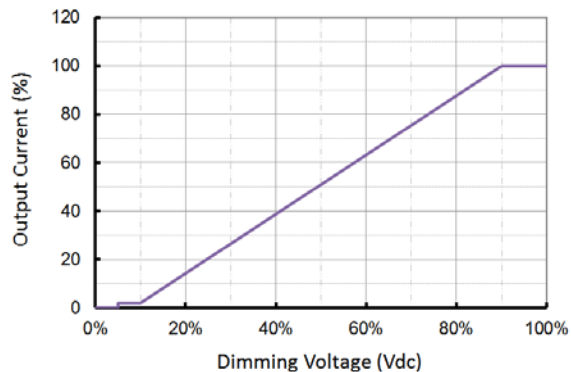

■ Lifetime vs. Case Temperature

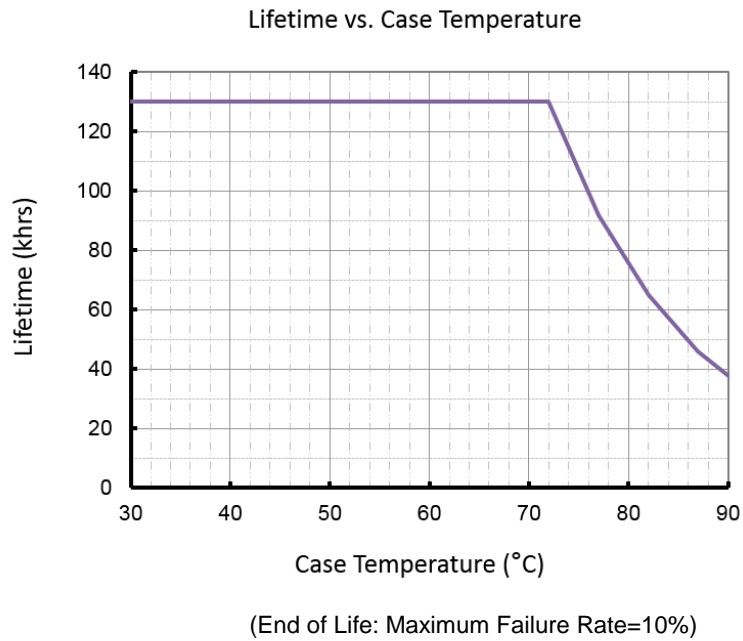

■ THD vs. Load

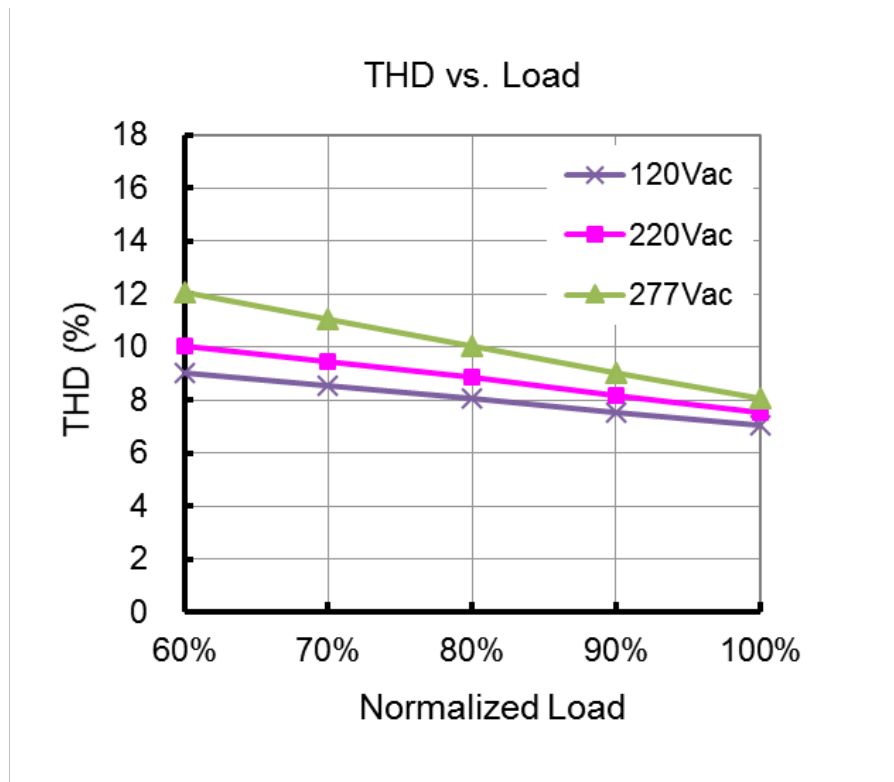

■ Mechanical Outline (Unit: mm)

Note: Dimensions in millimeters, where 25.4 mm = 1 inch

Tolerance: ± 0.51 mm

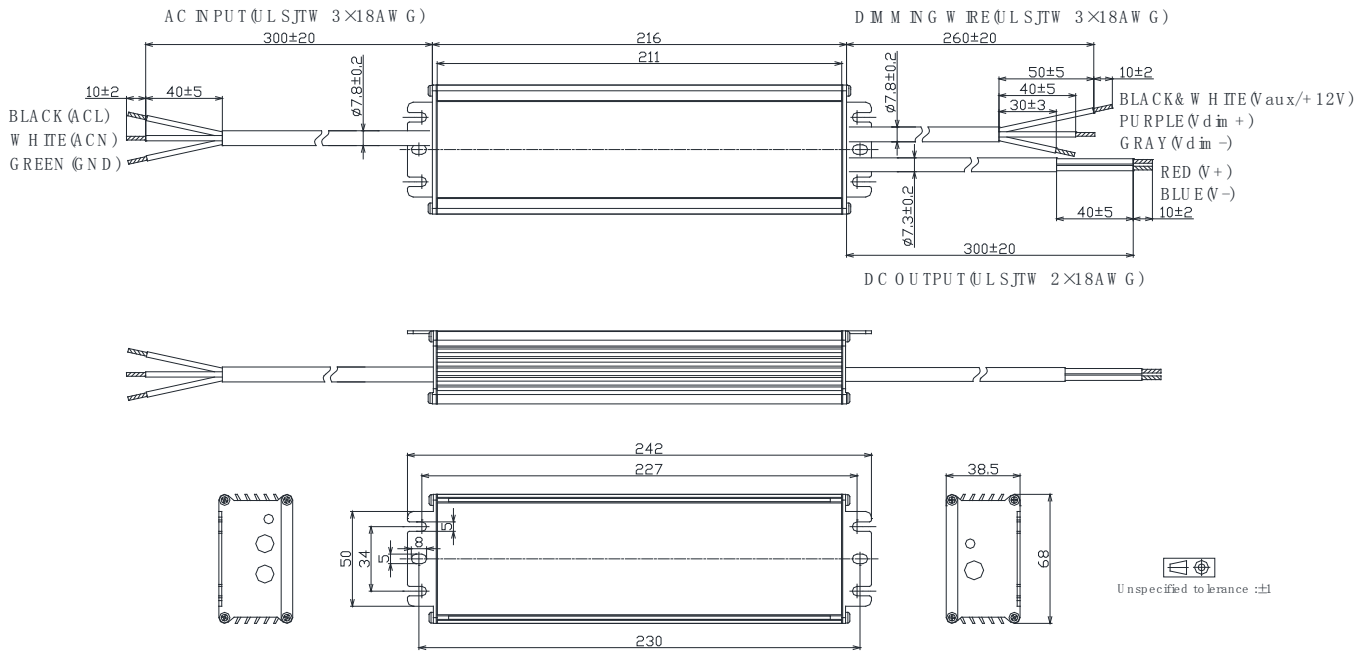

Figure 37, AR8PT

Safety Note: Please make sure the output cable does not connect to dimming cable or the cables of other drivers until 20 seconds after being tested because of the remained voltage in the output capacitor.

Revision

Date	Rev.	Description of Change		
		Item	Old	New
3/16/2018	V2a	In Draft Release	/	/