

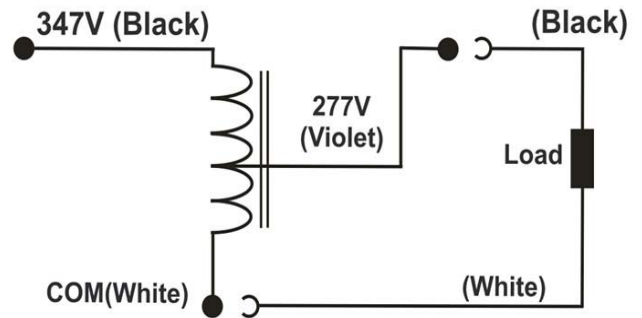

cUL[®] US RoHS ISO9001

Model No.	MTM00303427C
Product Type	Step-down Transformer
Rating (VA)	30
Vin Vout	347VAC 277VAC
Frequency	60 Hz
Status	Production

Input Voltage (V)		347	
Max Input Circuit (A)		0.10	
Max Output Circuit (A)		0.11	
Max. Load(VA)		30	
Output Voltage (V)		277	
Full Load	EFF. (%)	93	
	THD (%)	10.6	
	Power Factor	0.951	
UL Class B 130 Temp. Code		A	
Dimension (inches/mm)	Basic dimensions	A*	1.18±0.04/30±1
		B(Max)	2.2/56
		W	1.65±0.04/42±1
		H	1.34±0.04/34±1
	Installation dimensions	M1	1.28/32.6
		M2	1.91±0.04/48.6±2
		M3	0.57/14.4
		M4	2.13±0.04/54±2
		L	2.36±0.04/60±2
		Max Net Weight (lbs)	
Max Net Weight + LW (lbs)		0.83	
Lead Length (inches)		8±0.5	

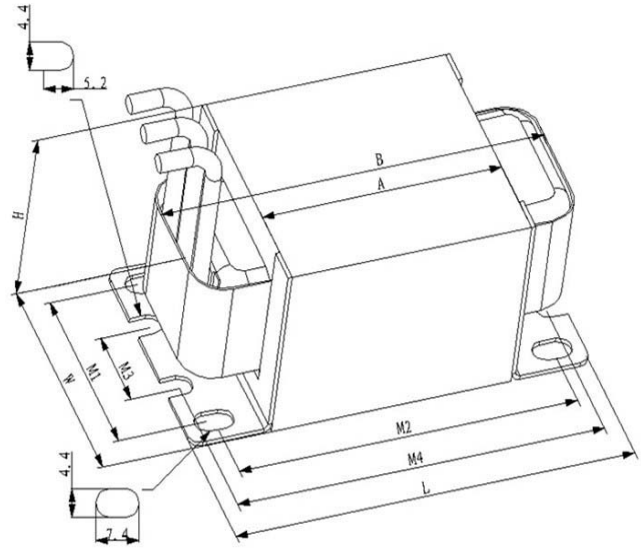

A* not covered the thickness of the two holders
 *Lead Type: (AVLV2, AVLV8), Type 3135, No. 18 AWG (or Equivalent), rated 200°C, 600 V. Strip 10mm Tin Plated.

Product Standards: UL 5085-1, UL 5085-2
 UL CCN: XPTQ2, XPTQ8

Document No.:	PS_MTM_VA0030_34-27_C_M03
Date:	2017-02-08 (yyyy-mm-dd)